

scandomestic



Wine cabinets



SV 19 B



| | |
|-------------------------------|------------------|
| Wine bottles, pcs | 18 |
| Temperature Zones | 1 |
| Noise level, dB(A) | 39 |
| Product dimensions, HxWxD, mm | 865 x 295 x 561 |
| Internal light | 1 Horizontal LED |
| EAN code | 5704704015111 |

- Stylish frameless black glass door
- Curved black stainless handle
- One temperature zone
- Ventilated anti-vibration cooling system
- Beech wooden shelves
- Digital controller with temperature display
- Low noise and vibration
- Freestanding and build-in model

SV 19 B is both a freestanding and build-in model. The wine cabinet has one temperature zone and can be adjusted between 5°C – 18°C. With 5 pull-out shelves + 1 shelf in beech wood it can hold 18 bottles. A fine cabinet for wine storage.

The cabinet has a timeless design. The black frameless door and the interior light give the cabinet an exclusive look. Right-hinged door with option for door reversing gives you the flexibility to place the wine cabinet anywhere in the room.

1 horizontal LED light provides a good light and represents the wine bottles nicely. The cabinet has an intelligent air circulation system, that ensures perfectly ventilated, anti-vibration cooling throughout the entire cabinet.

SV 19 B has UV-glass and is electronically controlled. The digital control panel makes it easier to see and adjust the temperature in the cabinet.

Measurement Drawings

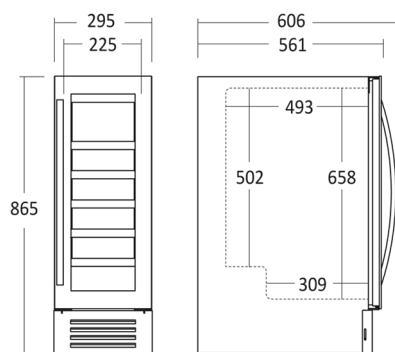

Number of wine bottles

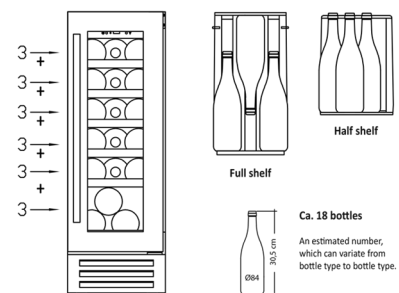



SV 45 B



| | |
|-------------------------------|------------------|
| Wine bottles, pcs | 45 |
| Temperature Zones | 1 |
| Noise level, dB(A) | 39 |
| Product dimensions, HxWxD, mm | 845 x 540 x 548 |
| Internal light | 1 Horizontal LED |
| EAN code | 5704704014497 |

- Black glass door with thin frame
- Freestanding model
- One temperature zone
- Temperature range 4-22°C
- Digital controller with temperature display
- Reversible door
- Beech wooden shelves

SV 45 B is a freestanding wine cabinet with one temperature zone. The temperature in the cabinet can be adjusted between 4°C – 22°C, and with 5 pull-out shelves + 1 shelf in beech wood it can hold 45 bottles. A fine cabinet for wine storage.

The cabinet has a timeless design. The black frameless door and the interior light give the cabinet an exclusive look. Right-hinged door with option for door reversing gives you the flexibility to place the wine cabinet anywhere in the room.

1 horizontal LED light provides a good light and represents the wine bottles nicely. The cabinet has an intelligent air circulation system, that ensures perfectly ventilated, anti-vibration cooling throughout the entire cabinet.

SV 45 B is electronically controlled and has a digital control panel, making it easier to see and adjust the temperature in the cabinet.

Measurement Drawings

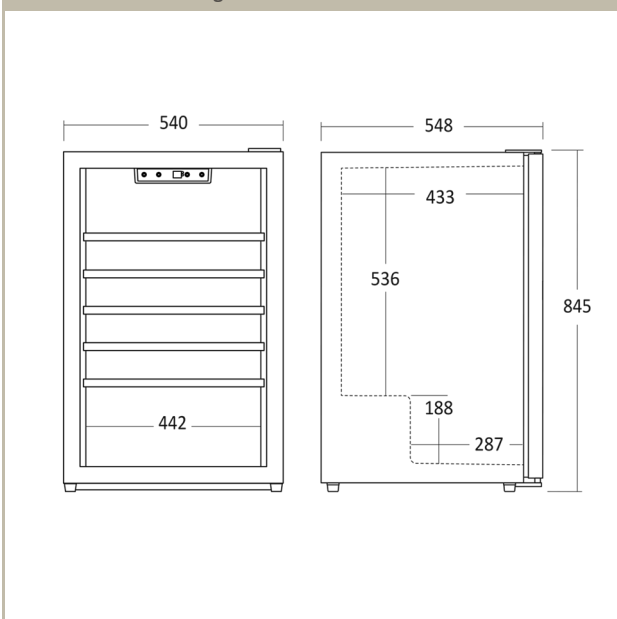

Number of wine bottles

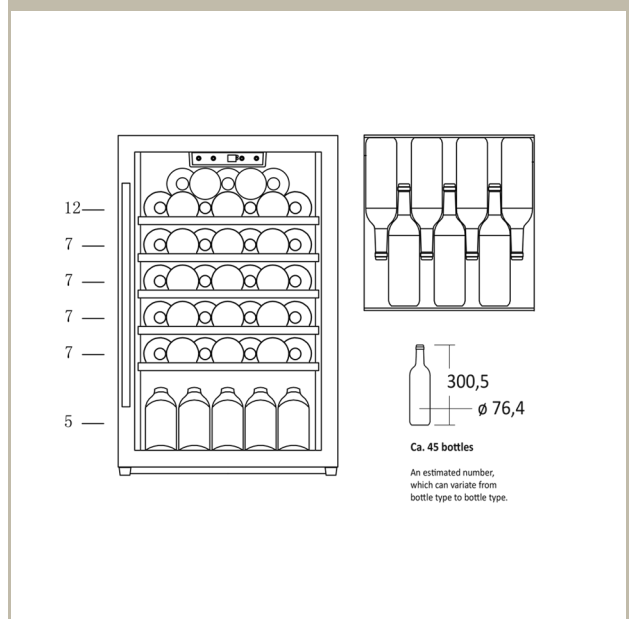



SV 81 B



| | |
|-------------------------------|------------------|
| Wine bottles, pcs | 46 |
| Temperature Zones | 1 |
| Noise level, dB(A) | 40 |
| Product dimensions, HxWxD, mm | 865 x 595 x 561 |
| Internal light | 1 Horizontal LED |
| EAN code | 5704704015128 |

- Stylish frameless black glass door
- Curved black stainless handle
- One temperature zone
- Ventilated anti-vibration cooling system
- Beech wooden shelves
- Digital controller with temperature display
- Low noise and vibration
- Freestanding and build-in model

SV 81 B is both a freestanding and build-in model. The wine cabinet has one temperature zone and can be adjusted between 5°C – 18°C. With 5 pull-out shelves + 1 shelf in beech wood it can hold 46 bottles. A fine cabinet for wine storage.

The cabinet has a timeless design. The black frameless door and the interior light give the cabinet an exclusive look. Right-hinged door with option for door reversing gives you the flexibility to place the wine cabinet anywhere in the room.

1 horizontal LED light provides a good light and represents the wine bottles nicely. The cabinet has an intelligent air circulation system, that ensures perfectly ventilated, anti-vibration cooling throughout the entire cabinet.

SV 81 B has UV-glass and is electronically controlled. The digital control panel makes it easier to see and adjust the temperature in the cabinet.

Measurement Drawings

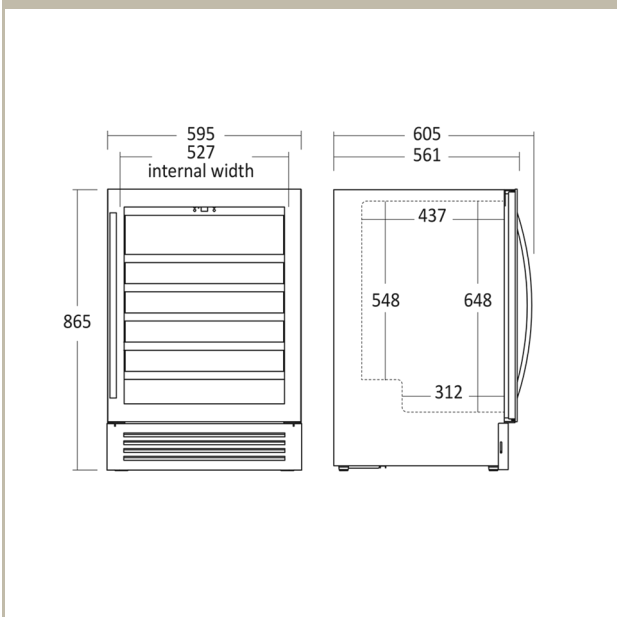

Number of wine bottles

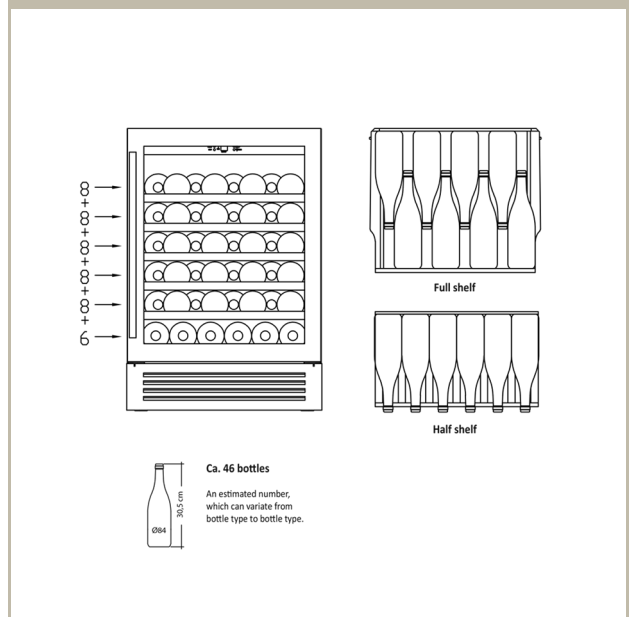



SV 85 B



| | |
|-------------------------------|------------------|
| Wine bottles, pcs | 44 |
| Temperature Zones | 2 |
| Noise level, dB(A) | 39 |
| Product dimensions, HxWxD, mm | 865 x 595 x 561 |
| Internal light | 2 Horizontal LED |
| EAN code | 5704704015135 |

- Stylish frameless black glass door
- Curved black stainless handle
- Two temperature zones
- Ventilated anti-vibration cooling system
- Bech wooden shelves
- Digital controller with temperature display
- Low noise and vibration
- Freestanding and build-in model

SV 85 B is both a freestanding and build-in model. The wine cabinet has two temperature zones that can be adjusted between 5°C – 18°C independently of each other. With 4 pull-out shelves + 1/2 shelf in beech wood it can hold 44 bottles. A fine cabinet for wine storage.

The cabinet has a timeless design. The black frameless door and the interior light give the cabinet an exclusive look. Right-hinged door with option for door reversing gives you the flexibility to place the wine cabinet anywhere in the room.

2 horizontal LED light provide a good light and represent the wine bottles nicely. The cabinet has an intelligent air circulation system, that ensures perfectly ventilated, anti-vibration cooling throughout the entire cabinet.

SV 85 B has UV-glass and is electronically controlled. The digital control panel makes it easier to see and adjust the temperature in the cabinet.

Measurement Drawings

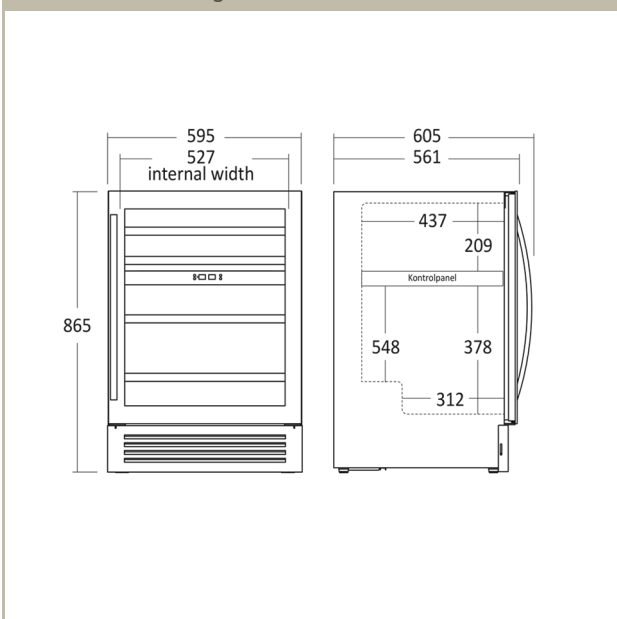

Number of wine bottles

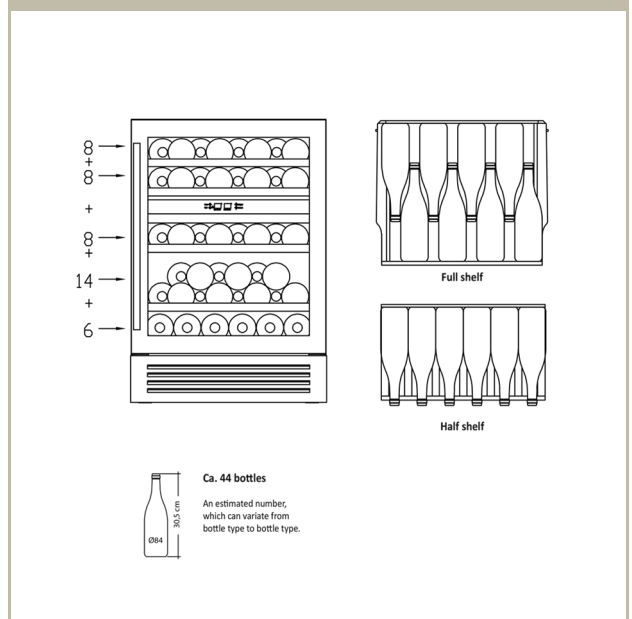



SV 104 B



| | |
|-------------------------------|------------------|
| Wine bottles, pcs | 90 |
| Temperature Zones | 2 |
| Noise level, dB(A) | 39 |
| Product dimensions, HxWxD, mm | 1392 x 595 x 680 |
| Internal light | 2 Horizontal LED |
| EAN code | 5704704015142 |

- Stylish frameless black glass door
- Curved black stainless handle
- Two temperature zones
- Ventilated anti-vibration cooling system
- Bech wooden shelves
- Digital controller with temperature display
- Low noise and vibration
- Freestanding and build-in model

SV 104 B is both a freestanding and build-in model. The wine cabinet has two temperature zones that can be adjusted between 5°C – 18°C independently of each other. With 5 1/2 pull-out shelves + 1 shelf in beech wood it can hold 90 bottles. A fine cabinet for wine storage.

The cabinet has a timeless design. The black frameless door and the interior light give the cabinet an exclusive look. Right-hinged door with option for door reversing gives you the flexibility to place the wine cabinet anywhere in the room.

2 horizontal LED light provide a good light and represent the wine bottles nicely. The cabinet has an intelligent air circulation system, that ensures perfectly ventilated, anti-vibration cooling throughout the entire cabinet.

SV 104 B has UV-glass and is electronically controlled. The digital control panel makes it easier to see and adjust the temperature in the cabinet.

Measurement Drawings

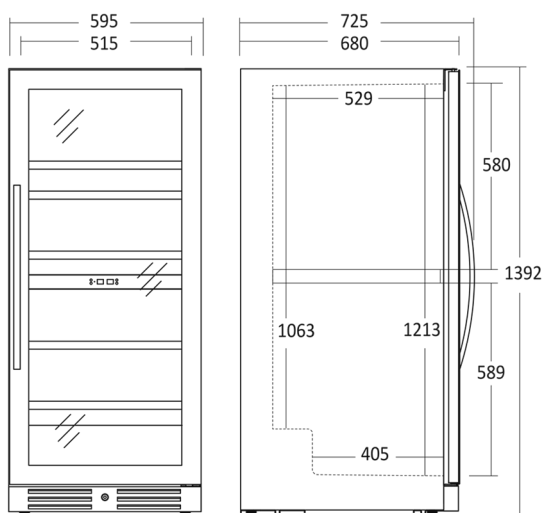

Number of wine bottles

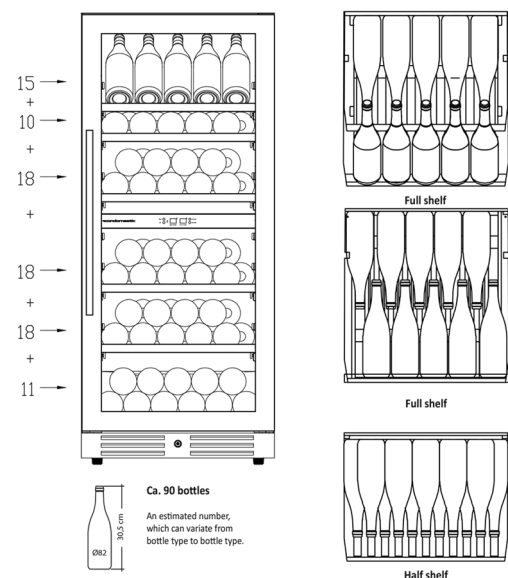



SV 111 B



| | |
|-------------------------------|------------------|
| Wine bottles, pcs | 126 |
| Temperature Zones | 1 |
| Noise level, dB(A) | 39 |
| Product dimensions, HxWxD, mm | 1764 x 595 x 680 |
| Internal light | 1 Horizontal LED |
| EAN code | 5704704015159 |

- Stylish frameless black glass door
- Curved black stainless handle
- One temperature zone
- Ventilated anti-vibration cooling system
- Beech wooden shelves
- Digital controller with temperature display
- Low noise and vibration
- Freestanding and build-in model

SV 111 B is both a freestanding and build-in model. The wine cabinet has one temperature zone and can be adjusted between 5°C – 18°C. With 7 1/2 pull-out shelves + 1 shelf in beech wood it can hold 126 bottles. A fine cabinet for wine storage.

The cabinet has a timeless design. The black frameless door and the interior light give the cabinet an exclusive look. Right-hinged door with option for door reversing gives you the flexibility to place the wine cabinet anywhere in the room.

1 horizontal LED light provides a good light and represents the wine bottles nicely. The cabinet has an intelligent air circulation system, that ensures perfectly ventilated, anti-vibration cooling throughout the entire cabinet.

SV 111 B has UV-glass and is electronically controlled. The digital control panel makes it easier to see and adjust the temperature in the cabinet.

Measurement Drawings

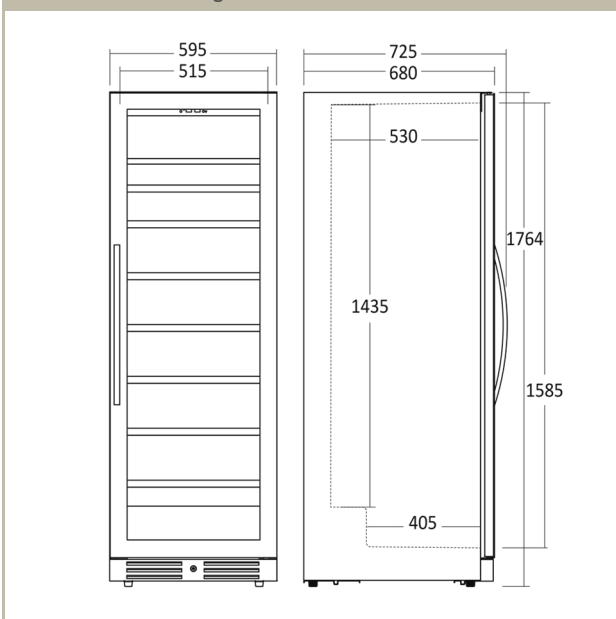

Number of wine bottles

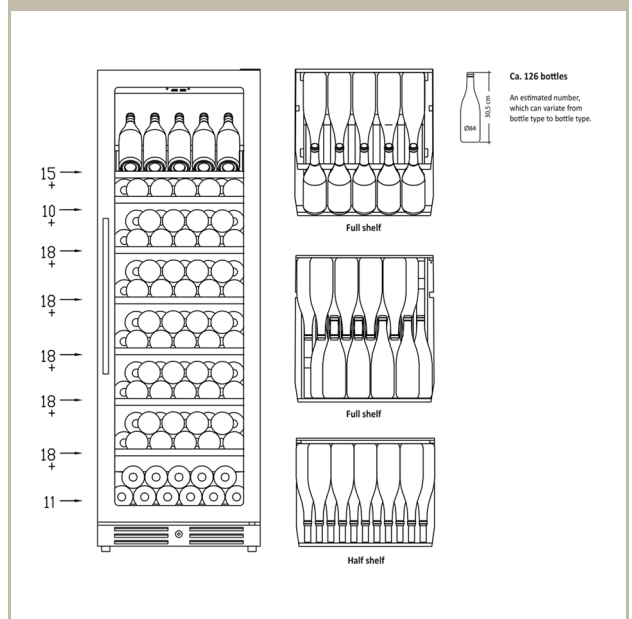



SV 124 B



| | |
|-------------------------------|------------------|
| Wine bottles, pcs | 126 |
| Temperature Zones | 2 |
| Noise level, dB(A) | 39 |
| Product dimensions, HxWxD, mm | 1764 x 595 x 680 |
| Internal light | 2 Horizontal LED |
| EAN code | 5704704015166 |

- Stylish frameless black glass door
- Curved black stainless handle
- Two temperature zones
- Ventilated anti-vibration cooling system
- Bech wooden shelves
- Digital controller with temperature display
- Low noise and vibration
- Freestanding and build-in model

SV 124 B is both a freestanding and build-in model. The wine cabinet has two temperature zones that can be adjusted between 5°C – 18°C independently of each other. With 6 pull-out shelves + 1 1/2 shelf in beech wood it can hold 126 bottles. A fine cabinet for wine storage.

The cabinet has a timeless design. The black frameless door and the interior light give the cabinet an exclusive look. Right-hinged door with option for door reversing gives you the flexibility to place the wine cabinet anywhere in the room.

2 horizontal LED light provide a good light and represent the wine bottles nicely. The cabinet has an intelligent air circulation system, that ensures perfectly ventilated, anti-vibration cooling throughout the entire cabinet.

SV 124 B has UV-glass and is electronically controlled. The digital control panel makes it easier to see and adjust the temperature in the cabinet.

Measurement Drawings

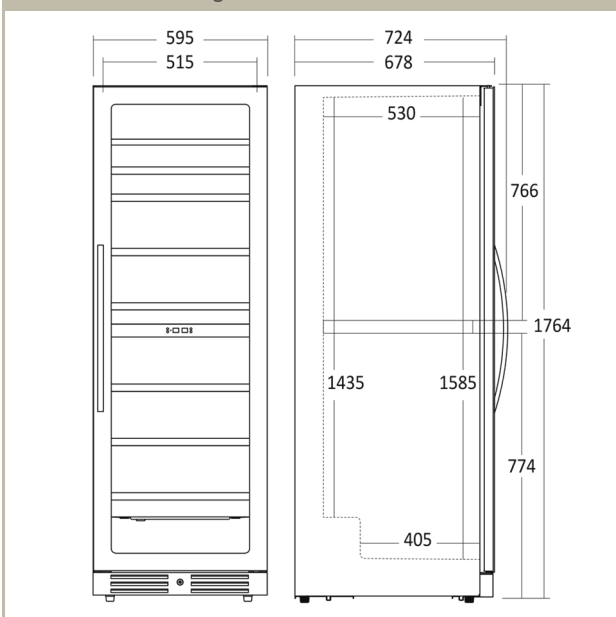

Number of wine bottles

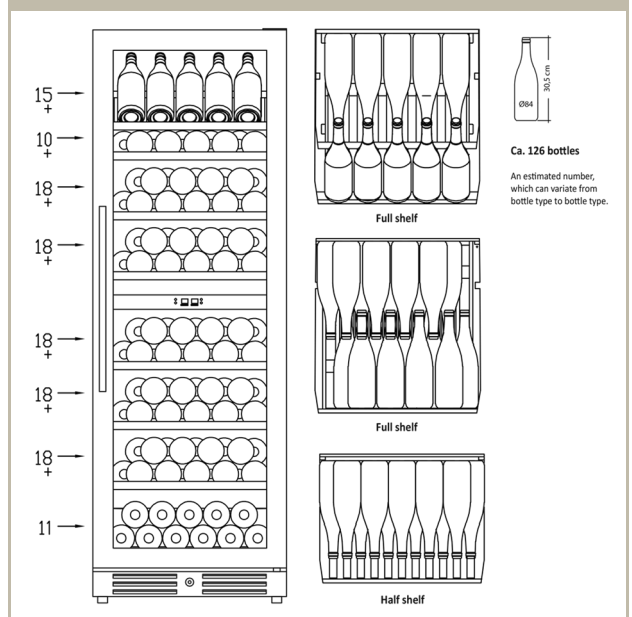



SV 138 B



| | |
|-------------------------------|------------------------------------|
| Wine bottles, pcs | 138 |
| Temperature Zones | 1 |
| Noise level, dB(A) | 39 |
| Product dimensions, HxWxD, mm | 1764 x 595 x 677 |
| Internal light | 10 Vertical LED + 1 Horizontal LED |
| EAN code | 5704704016538 |

- One temperature zone
- Touch display
- Exclusive, frameless glass door with lock
- 10 LED side lights and 1 LED top light
- 3 strong metal shelves
- Freestanding and built-in model
- Ventilated anti-vibration cooling system
- Low noise and vibration level

SV 138 B can be used both for built-in and as a freestanding service cabinet. The cabinet has one temperature zone and can be adjusted between 5°C – 18°C. With 3 strong metal shelves it can hold 138 upright wine bottles. A fine cabinet for wine storage.

The design is timeless. The intuitive touch display and the interior light give the cabinet an exclusive look. Right-hinged door with option for door reversing gives you the flexibility to place the wine cabinet anywhere in the room.

The cabinet comes with a lock and key to keep your bottles safe. 10 LED side lights and 1 LED top light provide a good light and represents the wine bottles nicely. The cabinet has an intelligent air circulation system, that ensures perfectly ventilated, anti-vibration cooling throughout the entire cabinet.

SV 138 B is electronically controlled and has a digital control panel, making it easier to see and adjust the temperature in the cabinet.

Measurement Drawings

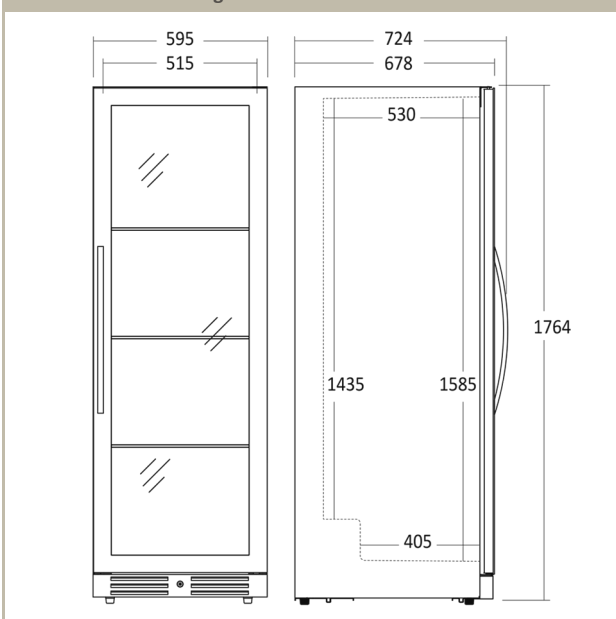

Number of wine bottles

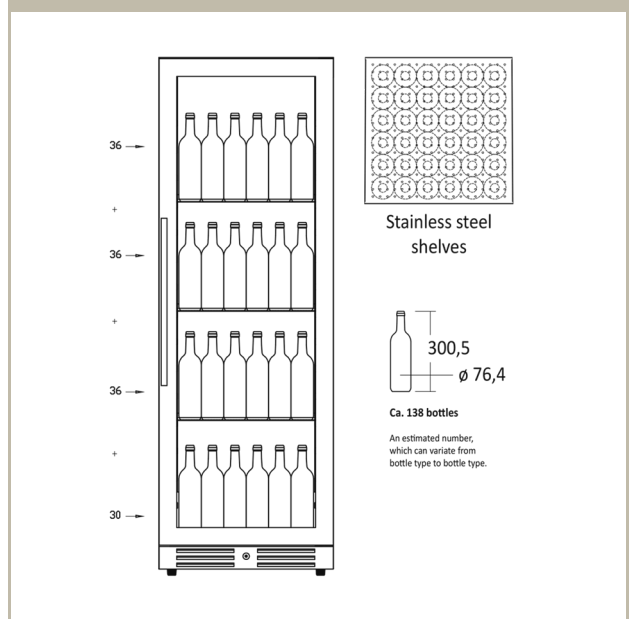



SV 1382 B

Control's b





| | |
|-------------------------------|------------------------------------|
| Wine bottles, pcs | 138 |
| Temperature Zones | 2 |
| Noise level, dB(A) | 39 |
| Product dimensions, HxWxD, mm | 1764 x 595 x 677 |
| Internal light | 10 Vertical LED + 2 Horizontal LED |
| EAN code | 55704704016545 |

- Two temperature zones
- Touch display
- Exclusive, frameless glass door with lock
- 10 LED side lights and 2 LED top lights
- 3 strong metal shelves
- Freestanding and built-in model
- Ventilated anti-vibration cooling system
- Low noise and vibration level

SV 1382 B can be used both for built-in and as a freestanding service cabinet. The cabinet has two temperature zones that can be adjusted between 5°C – 18°C independently of each other. With 3 strong metal shelves it can hold 138 upright wine bottles. A fine cabinet for wine storage.

The design is timeless. The intuitive touch display and the interior light give the cabinet an exclusive look. Right-hinged door with option for door reversing gives you the flexibility to place the wine cabinet anywhere in the room.

The cabinet comes with a lock and key to keep your bottles safe. 10 LED side lights and 2 LED top light provide a good light and represent the wine bottles nicely. The cabinet has an intelligent air circulation system, that ensures perfectly ventilated, anti-vibration cooling throughout the entire cabinet.

SV 138 B is electronically controlled and has a digital control panel, making it easier to see and adjust the temperature in the cabinet.

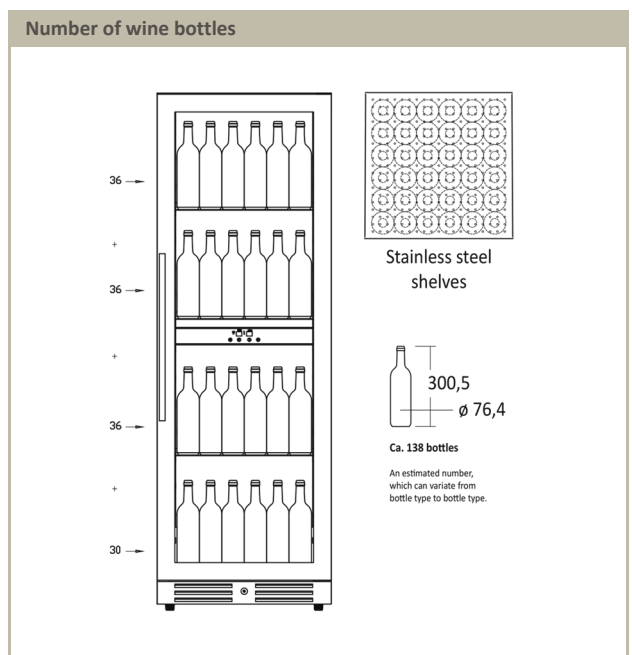
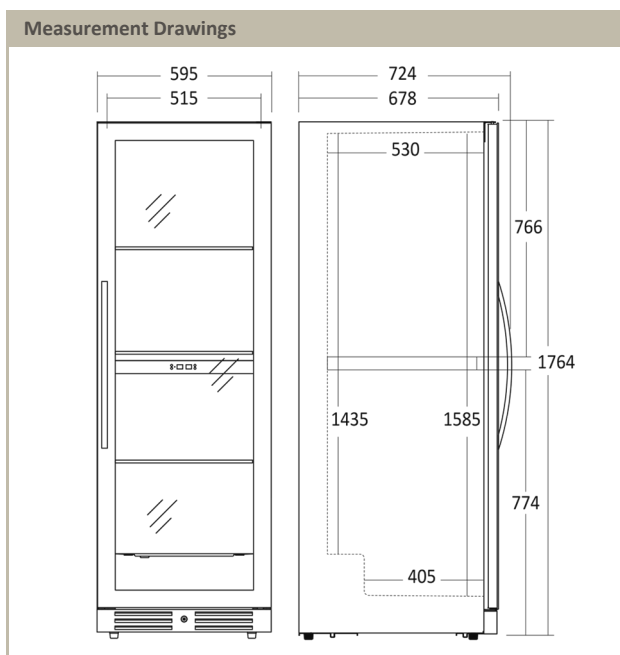



SV 81 X



| | |
|-------------------------------|------------------|
| Wine bottles, pcs | 46 |
| Temperature Zones | 1 |
| Noise level, dB(A) | 40 |
| Product dimensions, HxWxD, mm | 865 x 595 x 570 |
| Internal light | 1 Horizontal LED |
| EAN code | 5704704014121 |

- Stylish door frame in stainless steel
- Curved stainless steel handle
- One temperature zone
- Ventilated anti-vibration cooling system
- Beech wooden shelves with stainless trim
- Digital controller with temperature display
- Low noise and vibration
- Freestanding and build-in model

SV 81 X is both a freestanding and build-in model. The wine cabinet has one temperature zone and can be adjusted between 5°C – 18°C. With 5 pull-out shelves + 1 shelf in beech wood with metal edge trim it can hold 46 bottles. A fine cabinet for wine storage.

The cabinet has a timeless design. The door frame in stainless steel and the interior light give the cabinet an exclusive look. Right-hinged door with option for door reversing gives you the flexibility to place the wine cabinet anywhere in the room.

1 horizontal LED light provides a good light and represents the wine bottles nicely. The cabinet has an intelligent air circulation system, that ensures perfectly ventilated, anti-vibration cooling throughout the entire cabinet.

SV 81 X has UV-glass and is electronically controlled. The digital control panel makes it easier to see and adjust the temperature in the cabinet.

Measurement Drawings

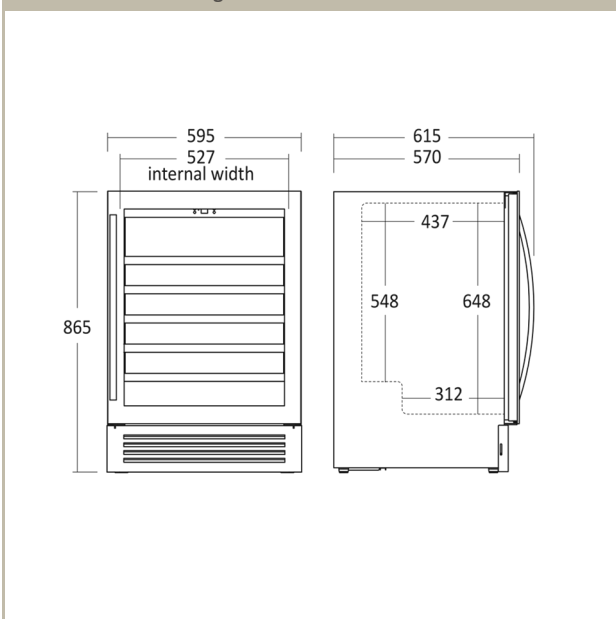

Number of wine bottles

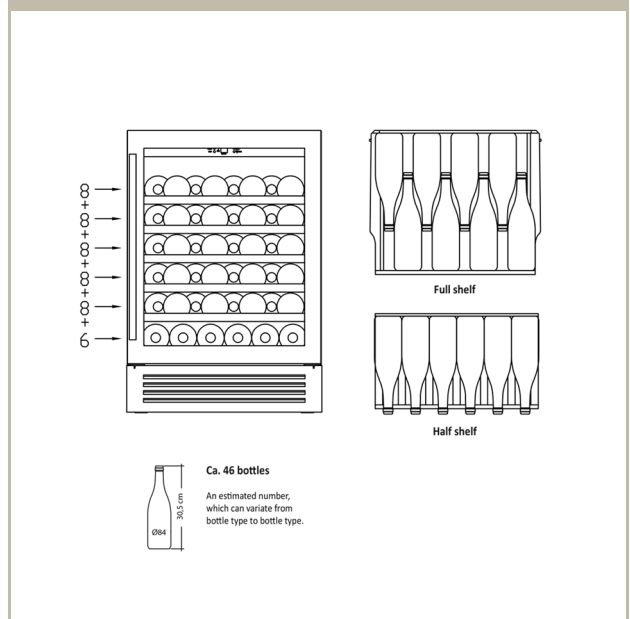



SV 91 X



| | |
|-------------------------------|------------------|
| Wine bottles, pcs | 36 |
| Temperature Zones | 2 |
| Noise level, dB(A) | 39 |
| Product dimensions, HxWxD, mm | 865 x 595 x 570 |
| Internal light | 2 Horizontal LED |
| EAN code | 5704704013100 |

- Stylish door frames in stainless steel
- Curved stainless steel handle
- Two temperature zones
- Ventilated anti-vibration cooling system
- Beech wooden shelves with stainless trim
- Digital controller with temperature display
- Low noise and vibration
- Freestanding and build-in model

SV 91 X is both a freestanding and build-in model. The wine cabinet has two temperature zones that can be adjusted between 5°C – 18°C independently of each other. With 10 pull-out shelves + 2 shelves in beech wood with metal edge trim it can hold 36 bottles. A fine cabinet for wine storage.

The cabinet has a timeless design. The door frame in stainless steel and the interior light give the cabinet an exclusive look. Right-hinged door with option for door reversing gives you the flexibility to place the wine cabinet anywhere in the room.

2 horizontal LED light provide a good light and represent the wine bottles nicely. The cabinet has an intelligent air circulation system, that ensures perfectly ventilated, anti-vibration cooling throughout the entire cabinet.

SV 91 X has UV-glass and is electronically controlled. The digital control panel makes it easier to see and adjust the temperature in the cabinet.

Measurement Drawings

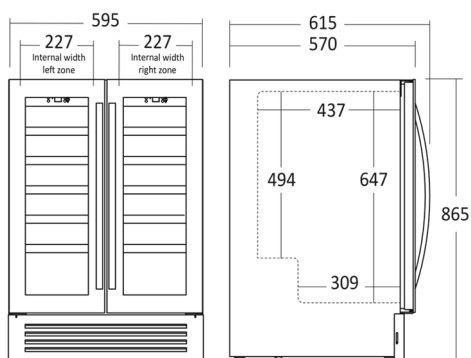

Number of wine bottles

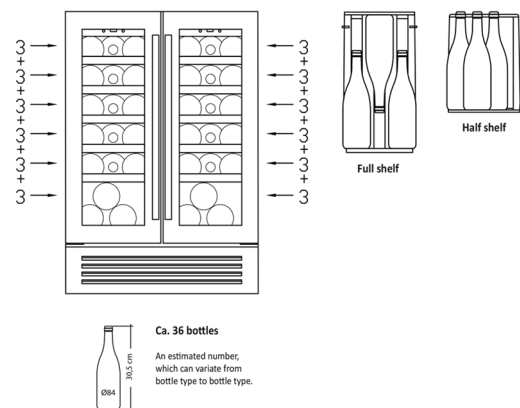



SV 104 X



| | |
|-------------------------------|------------------|
| Wine bottles, pcs | 90 |
| Temperature Zones | 2 |
| Noise level, dB(A) | 39 |
| Product dimensions, HxWxD, mm | 1392 x 595 x 678 |
| Internal light | 2 Horizontal LED |
| EAN code | 5704704014114 |

- Stylish door frame in stainless steel
- Curved stainless steel handle
- Two temperature zones
- Ventilated anti-vibration cooling system
- Bech wooden shelves with stainless trim
- Digital controller with temperature display
- Low noise and vibration
- Freestanding and build-in model

SV 104 X is both a freestanding and build-in model. The wine cabinet has two temperature zones that can be adjusted between 5°C – 18°C independently of each other. With 5 1/2 pull-out shelves + 1 shelf in beech wood with metal edge trim it can hold 90 bottles. A fine cabinet for wine storage.

The cabinet has a timeless design. The door frame in stainless steel and the interior light give the cabinet an exclusive look. Right-hinged door with option for door reversing gives you the flexibility to place the wine cabinet anywhere in the room.

2 horizontal LED light provide a good light and represent the wine bottles nicely. The cabinet has an intelligent air circulation system, that ensures perfectly ventilated, anti-vibration cooling throughout the entire cabinet.

SV 104 X has UV-glass and is electronically controlled. The digital control panel makes it easier to see and adjust the temperature in the cabinet.

Measurement Drawings

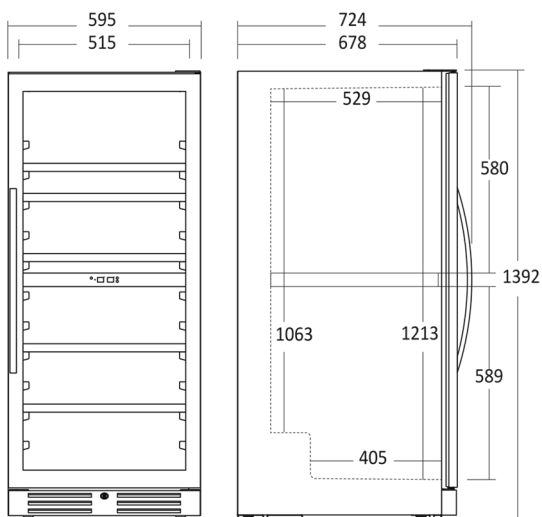

Number of wine bottles

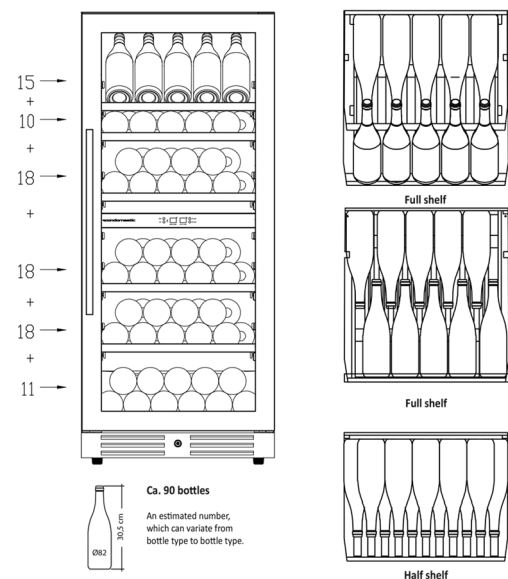



SV 124 X



| | |
|-------------------------------|------------------|
| Wine bottles, pcs | 126 |
| Temperature Zones | 2 |
| Noise level, dB(A) | 39 |
| Product dimensions, HxWxD, mm | 1763 x 595 x 678 |
| Internal light | 2 Horizontal LED |
| EAN code | 5704704013094 |

- Stylish door frame in stainless steel
- Curved stainless steel handle
- Two temperature zones
- Ventilated anti-vibration cooling system
- Bech wooden shelves with stainless trim
- Digital controller with temperature display
- Low noise and vibration
- Freestanding and build-in model

SV 124 X is both a freestanding and build-in model. The wine cabinet has two temperature zones that can be adjusted between 5°C – 18°C independently of each other. With 6 pull-out shelves + 1 ½ shelf in beech wood with metal edge trim it can hold 126 bottles. A fine cabinet for wine storage.

The cabinet has a timeless design. The door frame in stainless steel and the interior light give the cabinet an exclusive look. Right-hinged door with option for door reversing gives you the flexibility to place the wine cabinet anywhere in the room.

2 horizontal LED light provide a good light and represent the wine bottles nicely. The cabinet has an intelligent air circulation system, that ensures perfectly ventilated, anti-vibration cooling throughout the entire cabinet.

SV 124 X has UV-glass and is electronically controlled. The digital control panel makes it easier to see and adjust the temperature in the cabinet.

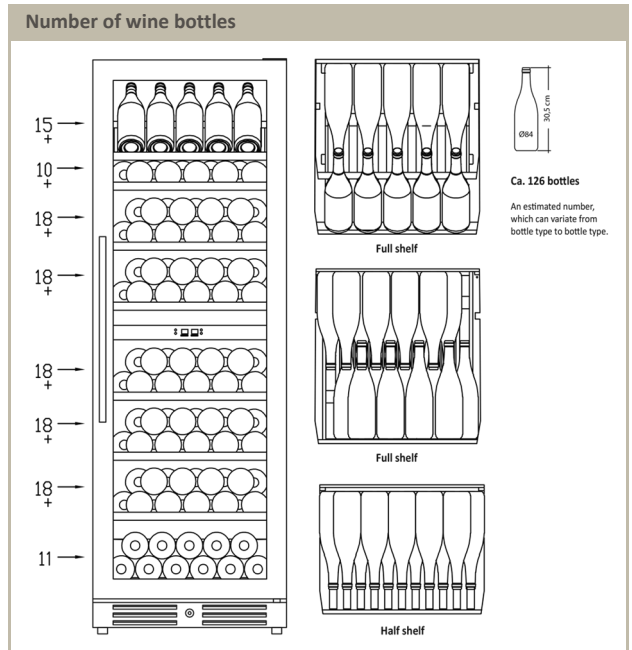
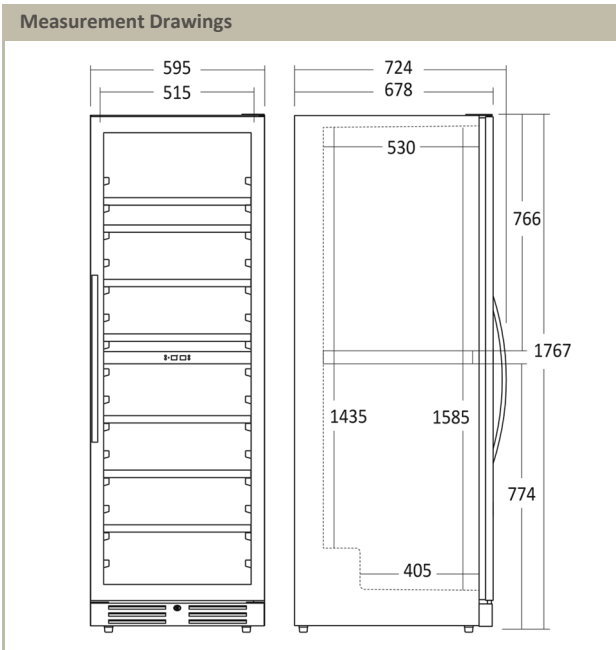



See other publications:

DK



UK



SE



scandomestic

Scandomestic A/S · DK-8600 Silkeborg · T + 45 7242 5571 · www.scandomestic.dk